



Components List

**The Pro Spot i5 comes with below listed parts except for parts listed as "Optional"

PRO SPOT

ORDER ONLINE @ shop.prospot.com



SHIPPING DATA:

Dimensions: 28" x 34" x 50"
Weight: 314lbs. (142 Kg.)

i5 w/ Chiller 220V 400V 480V

i5 Serial #

Checked By:

Instruction Manual Quick Start

PS-600 (Water-cooled Pneumatic Spot Gun Complete)

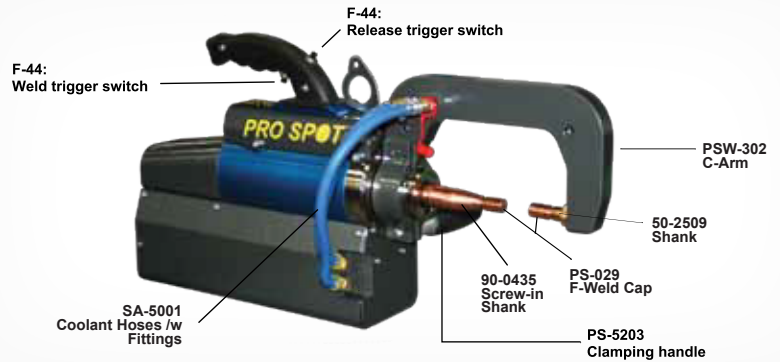

Shanks

**Typical i5 Shank Construction.

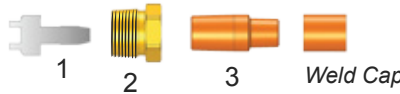



1. Divider - 90-0443
2. 1/2" NPT Insert - 90-0447
3. Shanks -

C-Arm - 50-2506 (1-1/2")	600mm - 50-2510 (2-1/2")
520mm - 50-2509 (2-1/4")	320mm - 50-2508 (2")

Weld Caps

A-Cap (conical cap) PS-030  5 pieces (included)

F-Cap (radius cap) PS-029  (optional)

B-Cap (round cap) PS-027  (optional)

**The i5 comes included with 5 A-Style Weld Caps. Additional caps come in packs of 15.

600mm U-Arm



600mm PSW-503 (optional)

50-2508 Shank 1 set

520mm U-Arm

1 set



520mm PSW-305

50-2509 Shank

320mm U-Arm

1 set



320mm PSW-309 (optional)

50-2508 Shank

Wheelhouse-Arm

Wheelhouse-Arm PSW-52 Shank Assembly SA-5002



1 set



HD, C to X Adapter (optional)



HD, C to X Adapter PSW-CX1 (optional)

90-0524 Angle Shank

1 set

C-Arm

C-Arm PSW-302 50-2506 Shank



1 set

Tethered Cap

52-0003





Components List

**The Pro Spot i5 comes with below listed parts except for parts listed as "Optional"

PRO SPOT

ORDER ONLINE @ shop.prospot.com

Overhead Boom

90-0356

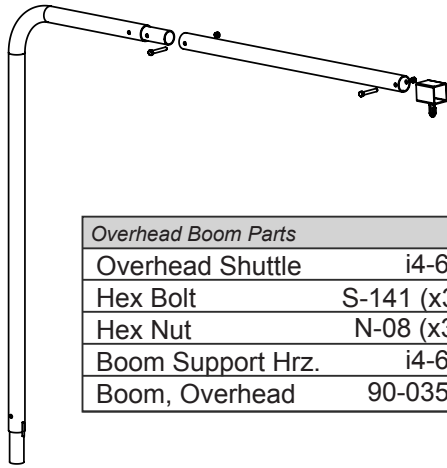

Overhead Boom Parts	
Overhead Shuttle	i4-62
Hex Bolt	S-141 (x3)
Hex Nut	N-08 (x3)
Boom Support Hrzs.	i4-61
Boom, Overhead	90-0356

Allen Wrenches

1 pc. each

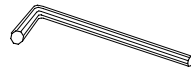

- 3mm CLT-57
- 4mm CLT-58
- 5mm CLT-58A

Tool Balancer

M-285 1 pc.



Weld Samples

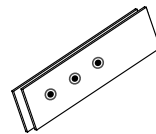

- 2 pc. 12" x 2" 50-2012
- 1 pc. 10" x 2" 50-2010
- 1 pc. 8" x 2" 50-2008

Welder Cover

80-0001 1 pc.



ShankTool

M-275 1 pc.



Tool Balancer Clip

C-09 2 pc.



Single Sided Welding Adapter & Accessories (Optional)

Single Sided Welding Adapter PS-SS1

(optional)

Pro Pull Not Included

1 set (Includes Electrode Kit)



SA-5551 Single Sided Electrode Kit

1 set



Carbon Electrode CLT-29



1 pc.

Single Sided Shank CLT-31-CM



1 pc.

Washer Adapter PS-840



1 pc.

Nail Adapter PS-820



1 pc.

5mm/6mm Stud Adapter PS-830



1 pc.

Rivet Adapter/Contact Shrinking PS-870



1 pc.

Nail PS-210



50 pc.

Clip Rivet PS-1204



100 pc.

Washer CLT-47



50 pc.

M5-12 Bolt PS-1201

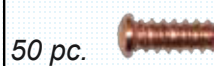

50 pc.

M5x18 Bolt PS-230



50 pc.

Washer CLT-44



20 pc.

Slide Hammer CLP-70



1 set

Contact Tip CLT-53-8



1 pc.

SS-Cap PS-025



1 pc.

M6x12 Bolt PS-1202



50 pc.