



Components List Rev.A v1.1

***The Pro Spot i4s comes with below listed parts except for parts listed as "Optional"*

PRO SPOT

ORDER ONLINE @ shop.prospot.com



i4s Serial #

Checked by/Date:

- 220 V
- 400 V

SHIPPING DATA:
 Dimensions: 48" X 40" X 60"
 Weight : 385 lb (175 kg)

PS-700W Spot Welding Gun, Liquid Cooled

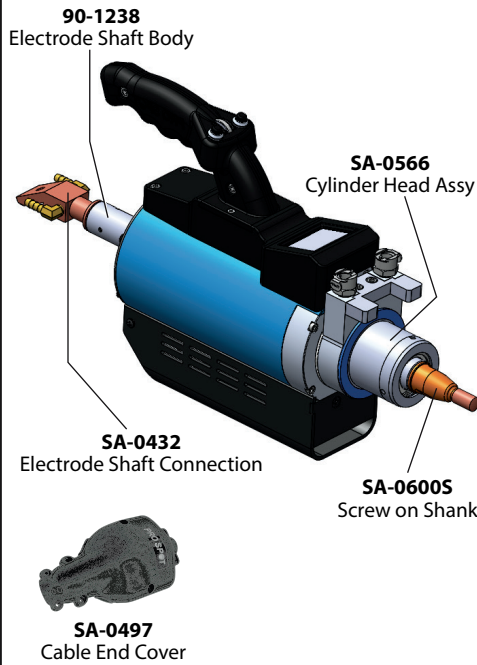

SA-0642 i4s Boom with Tool Balancer

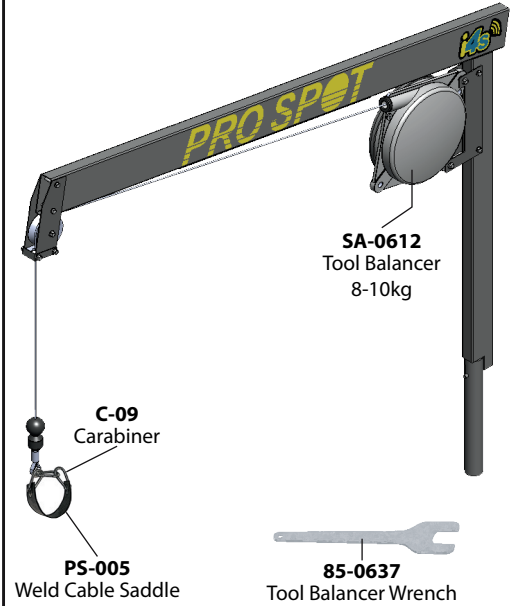

Note: Actual product may vary. All pictures shown are for illustration purpose only.

PS-3201-3 Single-Sided Gun Assembly

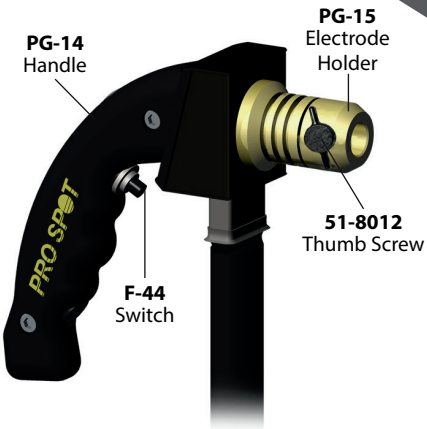

CLP-70 Spot Hammer



SA-0515 Cable Hanger

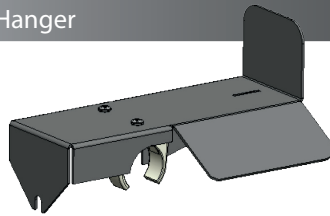

80-0001 Welder Cover



PSW-080 C-Arm , 80mm Depth

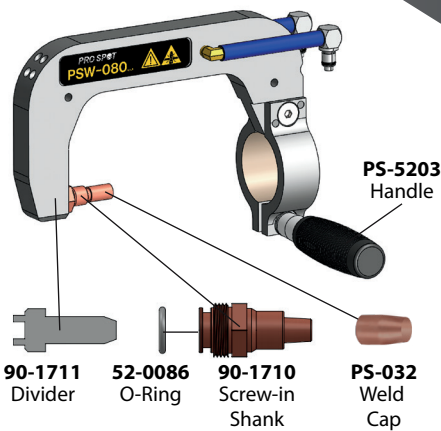

PSW-WH-090 Wheelhouse Arm, 90mm Depth

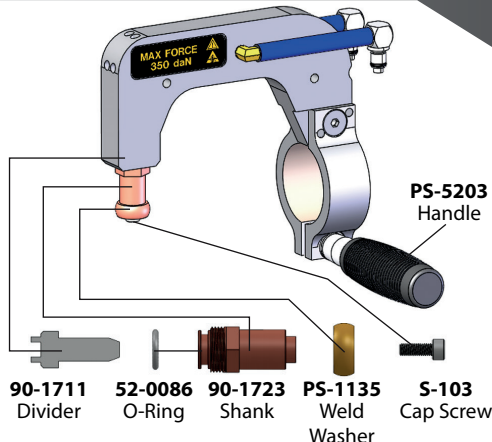

PSW-520 Extension Arm, 520mm Depth

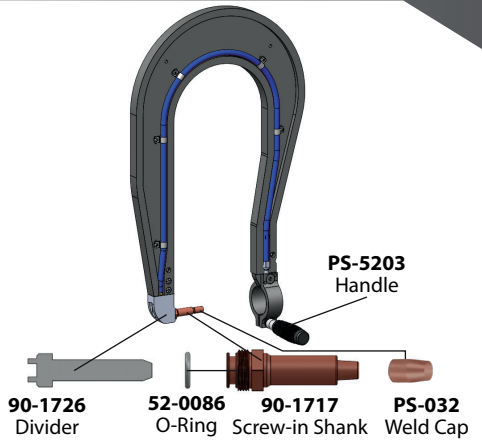

Copyright 2020 Pro Spot International Inc.





Components List Rev.A v1.1

***The Pro Spot i4s comes with below listed parts except for parts listed as "Optional"*

PRO SPOT



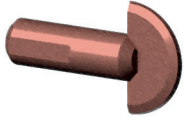
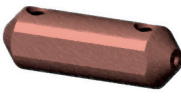
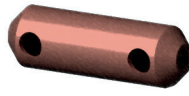
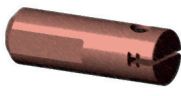













ORDER ONLINE @ shop.prospot.com

Inside the Tool Tray

CLT-33 Stitch Electrode	<input type="checkbox"/>	PS-820 Nail & 4mm Stud	<input type="checkbox"/>	PS-830 5mm & 6mm Stud	<input type="checkbox"/>	PS-840 Washer Adapter	<input type="checkbox"/>	PS-870 Moulding Clip & Contact Shrinking	<input type="checkbox"/>	50-2010 Weld Coupon, 2"x10"	<input type="checkbox"/>
											
1 pc.		1 pc.		1 pc.		1 pc.		1 pc.		2 pc.	

i4s ACCESSORY KIT

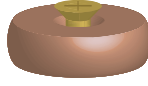
SA-0611 Rev.D

PS-1204 Moulding Clip Rivet		CLT-54 Allen Wrench - 2mm 1 pc.		CLT-31-CM Electrode Shank - Single Sided		CLT-53B 1 pc. Spot Hammer Contact Tip	
100 pc.		85-0002 Allen Wrench - 2.5mm 1 pc.		90-0451 Cooling Tube 1 pc.		CLT-29 1 pc. Carbon Electrode	
		CLT-57 Allen Wrench - 3mm 1 pc.					
		CLT-58A Allen Wrench - 5mm 1 pc.					
PS-1201 Weld-On Bolt M5x12 Coarse		CLT-44 Weld-On Nut, 6mm		PS-210 Nail 2.5 x 50mm		52-0086 5 pc. O-Ring - Arm Side	
50 pc.		20 pc.		50 pc.		52-0093 5 pc. O-Ring - Gun Side	
							7 pc.
PS-1202 Weld-On Bolt M6x12		PS-230 Weld-On Bolt M5x18 Coarse		CLT-47 Weld-On Washer		PS-032 Weld Cap	
50 pc.		50 pc.		50 pc.		6 pc.	
				90-1385S Wheelhouse Electrode Washer -1.394"OD			PS-023 Weld Cap, F-Cap
				1 pc.			
							6 pc.

OPTIONAL

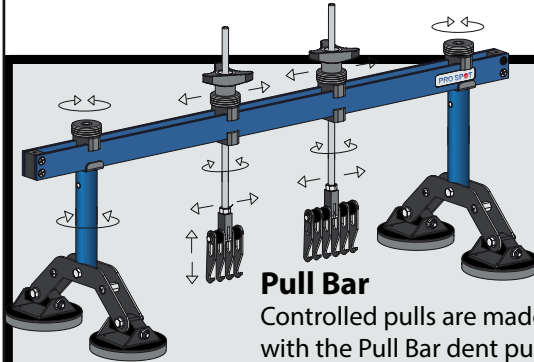

Pull Bar

Controlled pulls are made easy with the Pull Bar dent pulling system.

- PB-10** Four-Footed
- PB-11** Two-Footed

Weld Tab Dent Pulling

Expand your Single-Sided welding capabilities.

- 50-0016-50** Straight Tab 50pk

- 50-0017-50** Twisted Tab 50pk

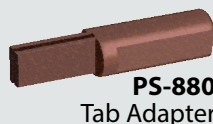

PS-880
Tab Adapter

Weld Caps

- PS-023/15** Weld Cap, F-Cap (15pk)
- PS-025/15** Weld Cap, A-Cap (15pk)
- PS-032/15** Weld Cap, .375" Radius (15pk)

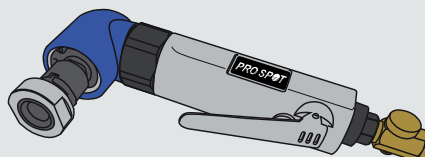

Electrode Tip Dresser

Extend the life of weld caps with Pro Spot's pneumatic tip dresser.

- PLT-46/A** .375 Radius Cap Dresser
- PLT-49/A** F-Cap Dresser
- PLT-50/A** A-Cap Dresser

Pro Pull

Pro Spot's patented tool for fast and accurate dent pulling in the single-sided welding mode.

Item# **PRO-66**



X-Arm

The Collision Industry's first full force C-X type weld arm.

Item# **CX-i4s**